

PRODUCT OVERVIEW : STD/ MULTI-COLOURED

PRODUCT OVERVIEW : INFRARED

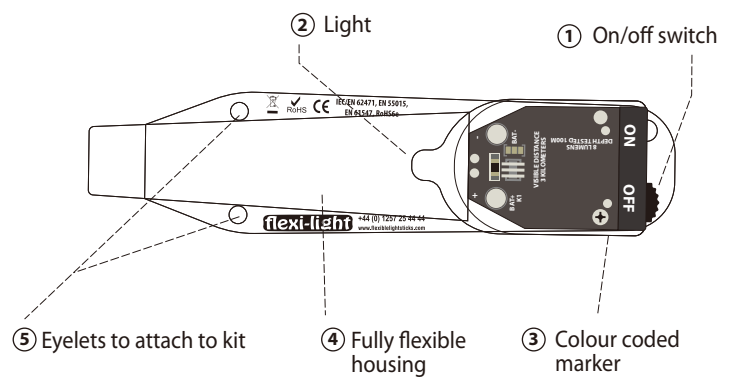
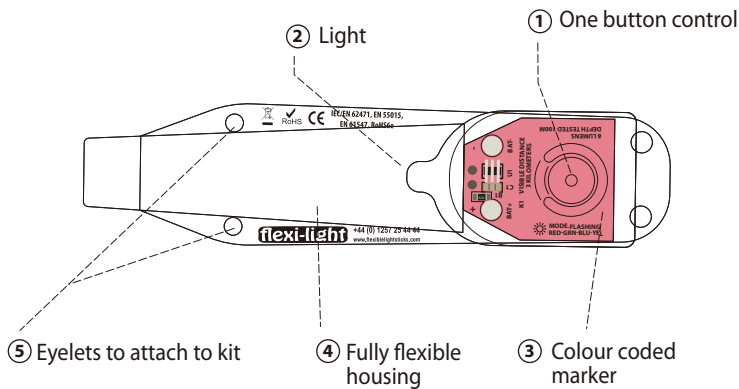

SPECIFICATION

Std V3 Types	Red, Blue, Green, Yellow, White
Other V3 Types	Multi-Colour or Infrared
Output	8 Lumens
Burn Time	22 - 42 Hrs
Visible Distance	3000m (9842')
Material	RoHS compliant polyurethane
Modes	Low, High, Flashing
Depth	100m (328')
Battery	Non-replacable
L*W*H	110*25*20mm (4.3*0.9*0.7")
Weight	30g (0.43lbs)
Fixing Options	Velcro Backing, Cable Ties, Re-usable Clip, Pockets

TORCH MODES

VERSION	MODE	BURN TIME
Standard	Low	40 hours
	High	20 hours
	Flashing	42 hours
Multi-Colour/IR	Flashing	42 hours

OPERATION

ONE BUTTON CONTROL - Easily turn on/off and cycle through the modes by pressing the button.

Standard model



Multi-colour model



IR model

SWITCH CONTROL

On/off with a simple switch left or right.

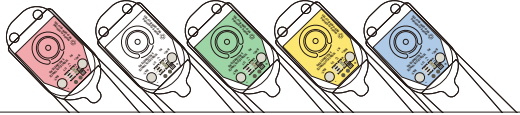
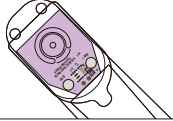
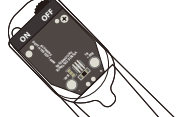

COLOUR IDENTIFICATION SYSTEM:

VERSION	MARKER COLOURS	COLOUR CODED MARKER
Standard	Red, white, green, yellow, blue	
Multi Colour	Purple	
Infrared	Black	

DIMENSIONS

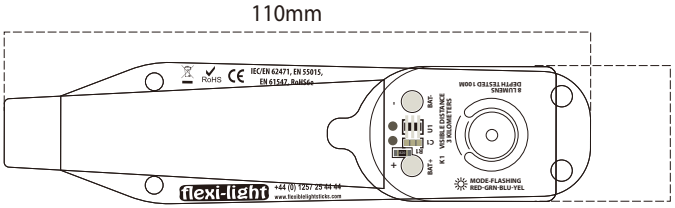

110mm

25mm







LxWxH
110*25*20mm



WEIGHT
0.025kg (0.05 lbs)

FIXING OPTIONS AND INSTALLATION

FIXING OPTION	INSTALLATION	VISUAL
3M Adhesive strip	Apply the adhesive strip to a clean, dry, non-porous surface. Press firmly and allow time to bond before use. Ideal for permanent mounting. Not suitable for rough, or wet materials where adhesion may weaken over time.	
Hook Velcro Fastening	Attach the hook strip to the Flexi Light and secure onto compatible loop Velcro surfaces. Provides quick removal and repositioning. Best suited for equipment with existing Velcro panels	
Removeable velcro pocket	Place the Flexi Light into the pocket and secure using the Velcro backing. Allows easy removal and visibility through the window. Compatible with loop Velcro surfaces on dive gear. Adds slight bulk and requires available Velcro mounting area.	
Nylon clip	Slide the Flexi Light into the nylon clip and secure with the locking bar to provide a secure, reusable fixing method. This fixing option works best for harnesses and BCDs and may not fit oversized or rigid mounting points.	
Fix-loc drysuit pocket	Insert the Flexi Light into the Fix-Loc pocket and clip securely onto compatible drysuit fittings. Designed specifically for drysuit integration.c Fix-Loc mounting systems.	

TROUBLESHOOTING

PROBLEM	RECOMMENDED ACTION
Light not turning on	Check button press sequence
Dim light	Battery nearing end of life
Intermittent operation	Ensure switch is fully engaged

WARRANTY

This product is covered by a 12-month warranty that applies exclusively to manufacturing defects. It does not cover misuse, neglect, or normal wear. The warranty is void if modified or opened. For claims, contact your retailer with the product and proof of purchase, or our customer care team. Approved claims replaced or replaced with an equivalent solution. We are not liable for consequential damage.

Warranty is non-transferable.



SAFETY AND MAINTENANCE INFORMATION

- Rinse in fresh water after salt water use
- Ensure the torch is completely dry before storage.
- Do not attempt to open, modify, puncture or cut this will void the warranty.
The battery is sealed and non replaceable
- Do not shine the light directly into eyes—may cause temporary or permanent blindness.
- Do not use if the housing is cracked or damaged. Check functionality before use in critical situations
- This is not a primary life-saving device.
- Dispose of according to local regulations

How did we do?



Your feedback is important to us, please leave us a review!

www.ndiver.com/review-us

HAVE YOU SIGNED UP TO OUR NEWSLETTER FOR THE LATEST NEWS, OFFERS AND NEW PRODUCTS?

NORTHERN DIVER
OPENWATER SUITS & EQUIPMENT

Email: info@ndiver.com

Telephone: +44 (0) 1257 25 44 44



Appley Lane North, Appley Bridge Wigan, Lancashire, WN6 9AE

CE  RoHS